



St. Albert Fire Services  
100 Giroux Road, St. Albert  
Alberta, T8N 3Z9  
780-418-6069  
[fireprevention@stalbert.ca](mailto:fireprevention@stalbert.ca)

## **St. Albert Fire Services Lock Box Standard**

Fire Department Lock Boxes within the City of St. Albert shall be the Knox Box. The National Fire Code, Alberta Edition (Section 2.5.1.3) requires the installation of a Fire Department approved Lock Box.

A building that incorporates fire protection equipment, elevator controls or door access shall provide a key box constructed, keyed, and located in a manner acceptable to the authority having jurisdiction containing a set or sets of keys or devices required to be used in an emergency.

### **Order Instructions**

- Visit the website: [www.knoxbox.com](http://www.knoxbox.com)
- Follow the “How to Buy Knox Products” on the following pages.
- Once your Knox Lock Box arrives, it is highly recommended to contact a Licensed Professional Locksmith for installation.
- Contact St. Albert Fire Services, Fire Prevention for mounting location.
- The Knox Lock Box shall be installed as per the manufactures instructions.
- The Knox Lock Box shall be installed adjacent to the main entrance or fire alarm panel or as per St. Albert Fire Services, Fire Prevention approval.
- The Knox Lock Box shall be installed so the top of the box is no higher than 1.8m (6ft) from the ground.
- Alterations or deviations will result in re-installation at the owner’s expense.
- After the Lock Box is installed, contact St. Albert Fire Services, Fire Prevention to have your Knox box and keys inspected for confirmation of completion.

For ordering assistance contact Knox Box Customer Service at 1-800-552-5669 ext. 1

1 To purchase a product, click the red **BUY** button located at the top right of the page.

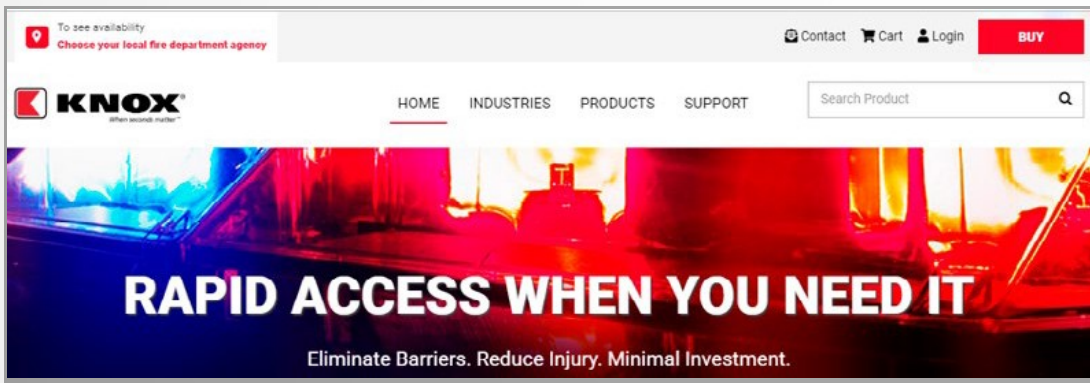

2 To view products available in the area where you're installing the Knox product, select "Your Location" **Alberta** and "Local Fire Department" **St Albert Fire SVCS**. Then, click on the Search button.

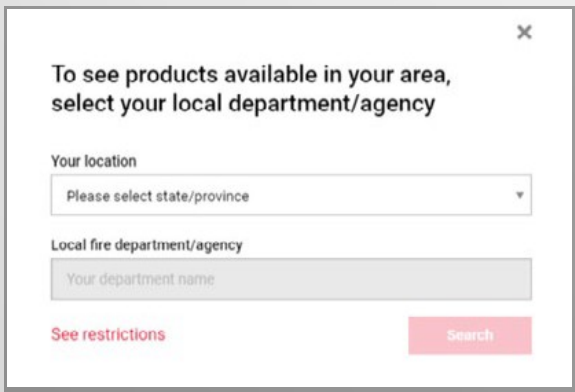

3 A list of fire departments will appear. **Select** your responding fire department or public agency.

**NOTE:** For duplicate fire department names, pay closer attention to the last line of each fire department listing, which may indicate specific access programs that have specific products available for that particular program.

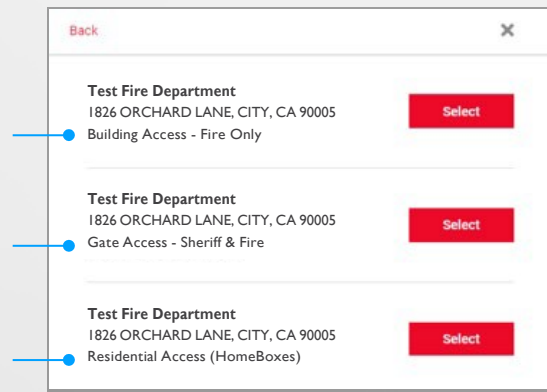

4 Once the selection has been made, you will be routed to the product category page. Product categories displayed may differ depending on your fire department.

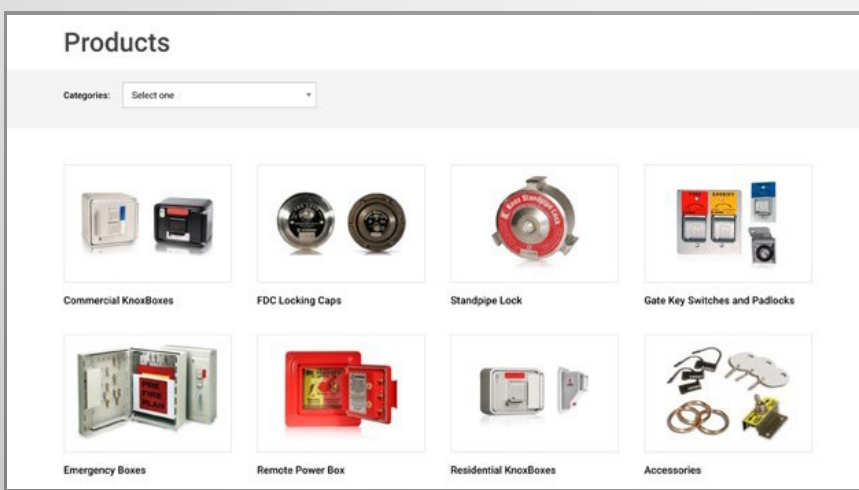

**5** To view products, click on a product category which will take you to the corresponding product page. Under the first section of the page, the system will indicate whether or not the product is available in the responding jurisdiction that you have selected. If the product is available, you will be able to view and configure the product.

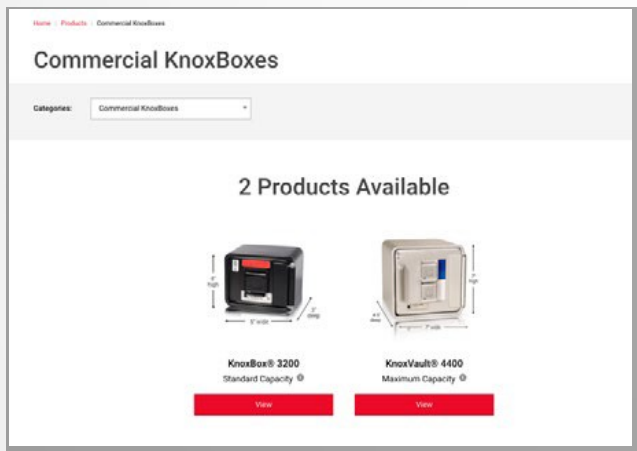

**6** To view the product, click on the **View** button which will take you to the configuration tool. Here you will be able to configure the product.

*Please note: Accessories do not have a configuration tool.*

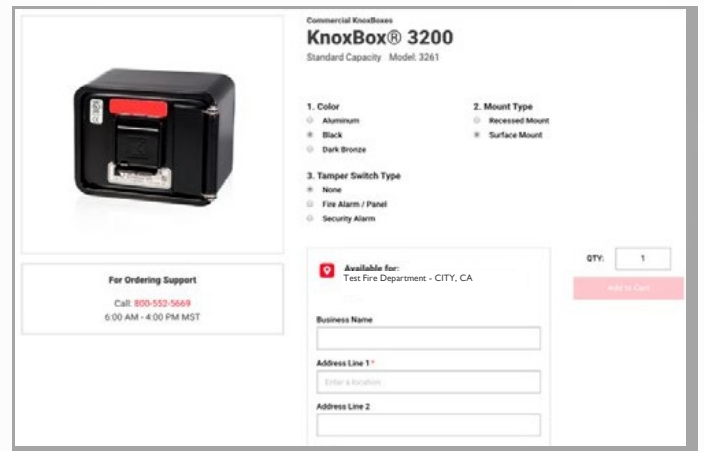

**7** Start configuring your product:

**a.** Customize your product by selecting the various attributes **(A)**.

If you know the specific model number that want to purchase, you can bypass the attribute selection by using the drop-down menu **(B)** to select the exact product.

**b.** Once you've selected or configured the product, enter the installation address **(C)** for this item and click **Submit**.

- You will be asked to confirm that you have selected the correct Fire Department (the Fire Department is listed above the Business Name field).
- Note:** If you need more than one of any item, each item requires an installation address. Note: Some items may not require an installation address.

**c.** Click the **Add to Cart** button **(D)**.

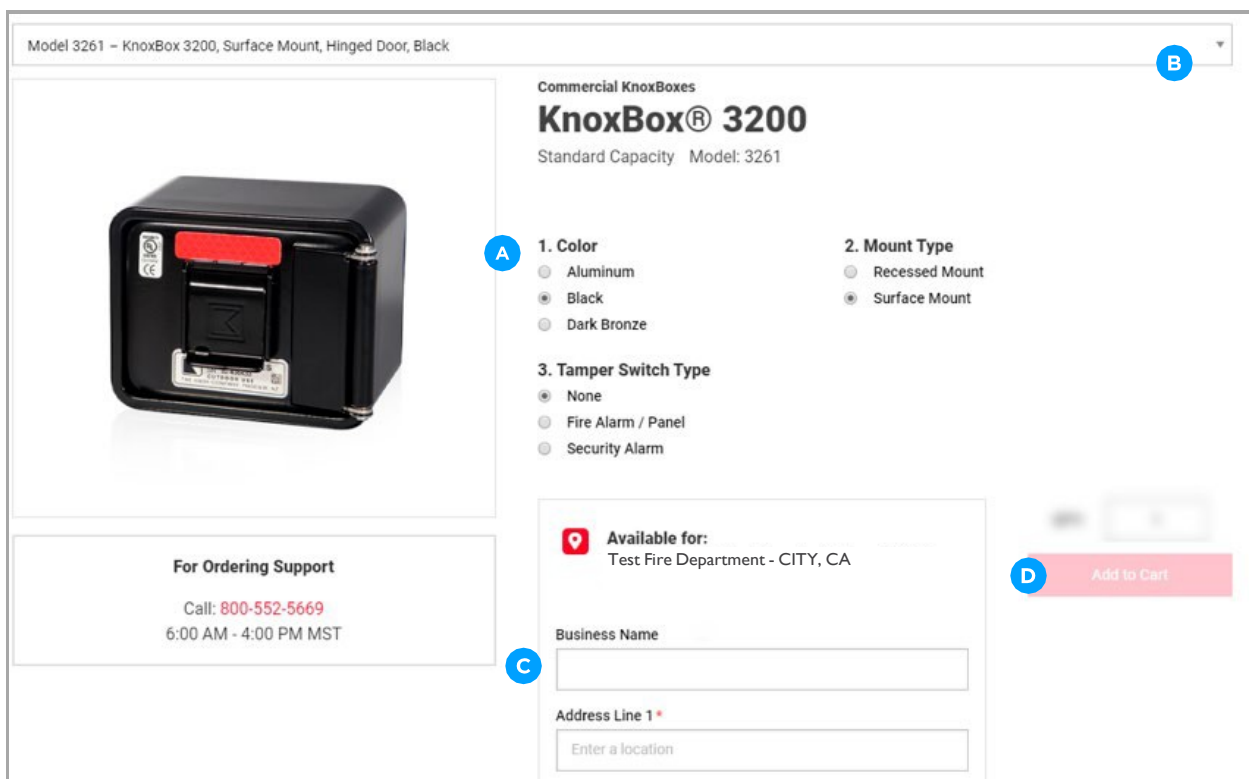

- 8 To continue the process, you will be asked to log in. If you are a new customer, complete the fields in the New Customer area.

## Login

### Returning Customer

Email Address

Please enter a user name

Password:

Stay signed in on this computer

[Sign in](#)

[Forgot Password?](#)

### New Customer

First name: \*

Last name: \*

Email: \*

Confirm Email Address \*

Phone Number: \*

Company: \*

Password: \*

Password strength: ●



Confirm password: \*

I agree to the [Terms and Conditions](#).

[Register](#)

- 9 Once you have logged on or created a new account, you will be returned to the Shopping Cart. To add more products, click **Continue Shopping** or if you're done adding products, click on **Checkout**.

## Shopping Cart

Product	Units	Price	Total
 <p><b>Model 4401 – KnoxVault 4400, Surface Mount, Single Lock, Black</b>  <small>Model: 4401            Installing to: Knox Company, 1601 W Deer Valley Rd            Phoenix, AZ, United States 85027</small></p>	1		
 <p><b>Model 3111 – Knox FDC Lock with Swivel-Guard, 2.5-inch, 3.068 X 7.5 TPI</b>  <small>Model: 3111            Installing to: Knox Company, 1601 W Deer Valley Rd            Phoenix, AZ, United States 85027</small></p>	2		
 <p><b>Model 1433 – Knox Elevator Box with FD Banner, Aluminum</b>  <small>Model: 1433            Installing to: Knox Company, 1601 W Deer Valley Rd            Phoenix, AZ, United States 85027</small></p>	1		

**Approving Department/Agency:**  
 Test Fire Department - CITY, CA

Sub-total	
Shipping	during checkout
Tax	Calculated
	during checkout
<b>Total</b>	<b>Calculated</b>
	<b>during checkout</b>

[Continue Shopping](#)

[Checkout](#)

**For Ordering Support**  
 Call: 800-552-5669  
 6:00 AM - 4:00 PM MST

10 During Checkout:

- a. Enter or confirm your Billing Address.

- b. If the shipping address is different from the billing address, select the 'Ship to a different address' check box:

- c. Click on the **Submit** button to proceed to the Shipping Method screen.
- d. Choose your Shipping Method and click on the **Continue** button to proceed to the Payment screen.
- e. Enter your Payment Information and click on the **Continue** button to proceed.
- f. Confirm your order or make changes to it.

- g. To complete your order, you MUST click the **Complete Order** button to complete your purchase.

**Note:** If your fire department needs to approve your purchase, your credit card or purchase order will not be charged until the department has approved your order.

KnoxBox 3200, the number one high-security key lock box trusted by emergency responders and property owners, is now available with the electronic Knox eLock Core™. Store up to 10 keys to gain rapid access to commercial properties. Box openings are recorded and tracked in the cloud-based KnoxConnect™ Management System.



Available in 3 colors:



## FEATURES

- Stores maximum 10 keys. Access cards and small entry items may also fit in interior compartment but will reduce max key quantity.
- Knox eLock Core, powered by Knox eKey™
- Dust cover reflective label for Knox eLock System identification
- Enables tracking of box openings via cloud-based KnoxConnect™
- Built Knox-Rugged and secure: UL 1037, UL 1610, UL 1332
- Finished with Knox-Coat® to protect four times better than standard powder coat
- Weather-resistant door gasket
- Knox RainGuard™ provides weather protection
- Hinged door

## BENEFITS

- No wiring or battery needed for power
- Captures box openings by date and time
- Allows rapid property access
- Reduces property damage
- Prevents forced entry into buildings
- Minimizes first responder injury
- Compliant to National Fire Code (NFPA, IFC, IBC)

## OPTIONS

- Knox Tamper Alert connects to building's alarm system for extra security
- Mount types: Recessed and Surface
- 3 color options: Black, Aluminum, Dark Bronze

## ACCESSORIES

- Multi-Purpose Switch for use on electrical doors, gates and other electrical equipment
- Recess Mounting Kit for new concrete or masonry construction
- Public Safety Labels
- Tag-Out Tamper Seals, Key Tags, and Key Rings

## ORDERING SPECIFICATIONS

To insure procurement and delivery of the Electronic KnoxBox 3200, it is suggested that following specification paragraph is used:

KnoxBox surface/recessed mount with hinged door, with/without UL Listed Knox Tamper Alert. 1/4" plate steel housing, 1/2" thick steel door with interior gasket seal and stainless steel door hinge. Box is UL Listed. Lock has 1/8" thick stainless steel dust cover with tamper seal mounting capability, a rainguard to protect against certain weather conditions and a reflective Knox label indicating the Knox eLock System.

**Exterior Dimensions:** Surface Mount Body - 4" H x 5" W x 3-7/8" D  
Recessed Mount Flange - 7" H x 7" W

**Electronic Lock:** Powered by Knox eKey. Communicates using industry standard encryption.

**Finish:** Knox-Coat proprietary finishing process

**Color:** Black, Dark Bronze or Aluminum

**P/N:** KnoxBox KLS-3200 (mfr's cat. ID)

**Mfr's Name:** KNOX COMPANY



### WEIGHT:

Surface Mount - 8 lbs.  
Recessed Mount - 9 lbs.

### DIMENSIONS:

Surface Mount Body - 4" H x 5" W x 3-7/8" D  
Recessed Mount Flange - 7" H x 7" W

#### SURFACE MOUNT - FRONT VIEW

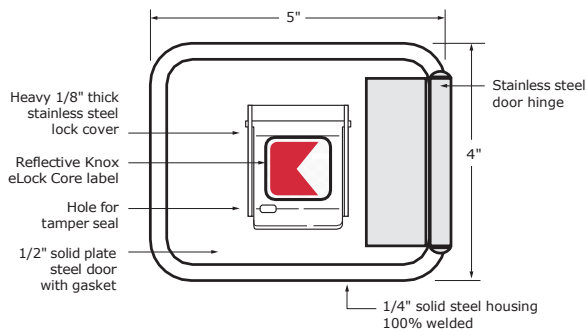

#### RECESS MOUNT - FRONT VIEW

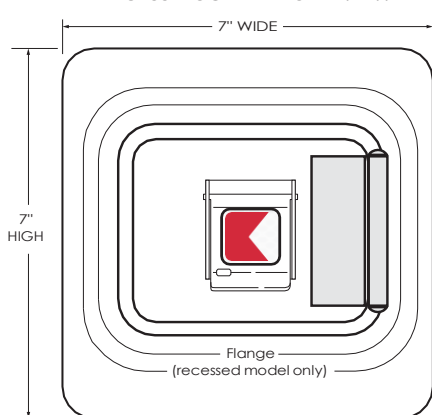

#### SIDE VIEW

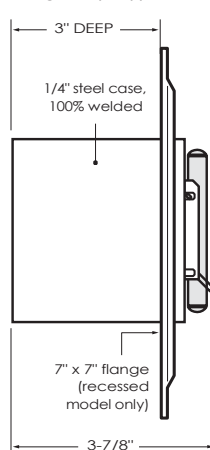

## GENERAL MOUNTING INSTRUCTIONS

Maximum mounting height,  
6 feet above ground.

**ATTENTION:** KnoxBox is a very strong device that **MUST** be mounted properly to ensure maximum security and resist physical attack.

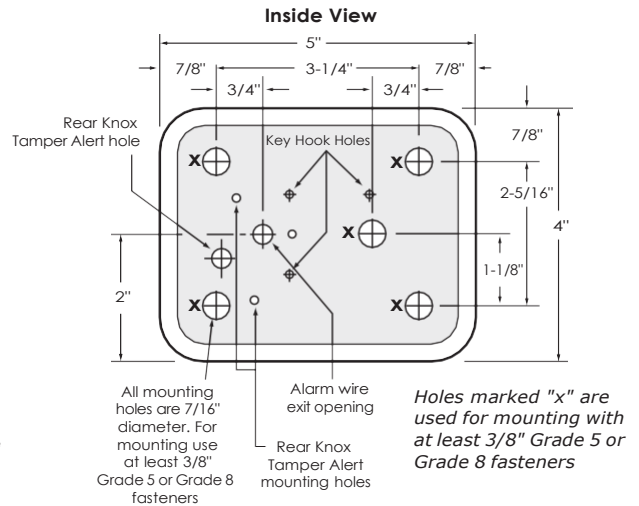
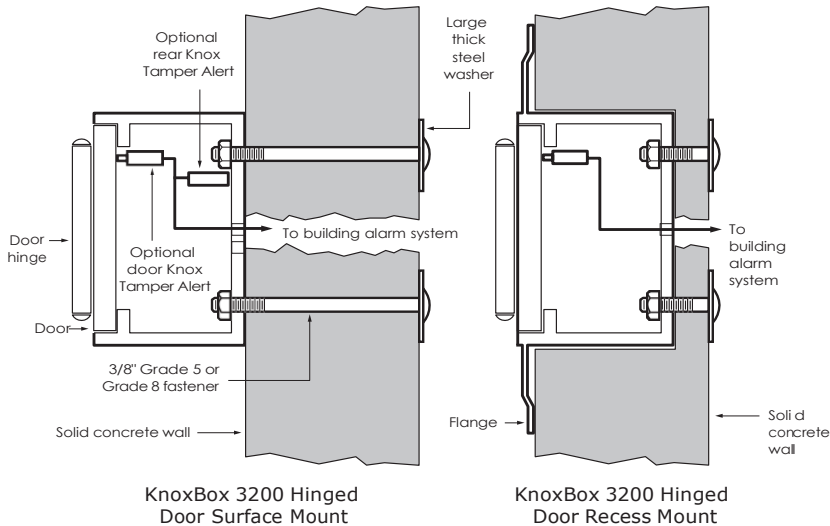

## RECESS MOUNTING KIT AND INSTALLATION INSTRUCTIONS

The Recess Mounting Kit (RMK) includes shell housing and mounting hardware, which may only be used for recessed models to cast-in-place within new concrete or masonry construction. The KnoxBox is mounted into the shell housing after construction is completed.

### RECESS MOUNTING KIT DIMENSIONS

Rough-in Dimensions:  
6-1/2" H x 6-1/2" W x 5" D

#### Recessed Mounting Using Recess Mounting Kit (RMK)

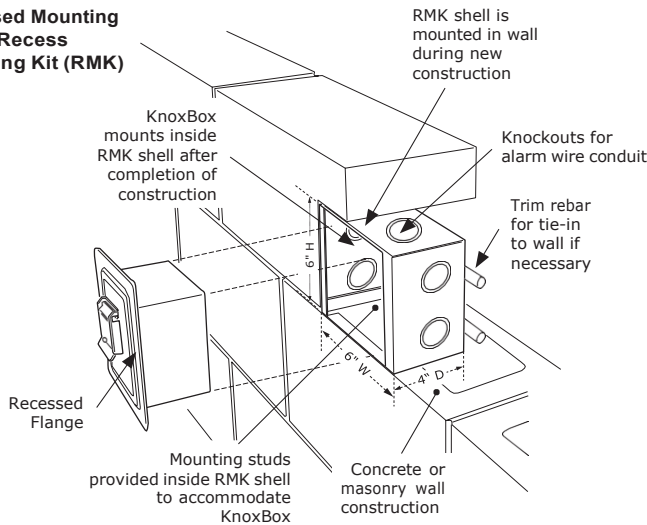

#### IMPORTANT:

Care should be taken to ensure the front of the Recess Mounting Kit (RMK) shell housing, including the cover plate and screw heads, is flush with the wall. The RMK must be plumbed to ensure vertical alignment of the box.

## ABOUT KNOX COMPANY

Over forty years ago, a unique concept in rapid access for emergency response was born. The KnoxBox®, a high-security key lock box, was designed to provide rapid access for emergency responders to reduce response times, minimize injuries and protect property from forced entry.

Today, one revolutionary lock box has grown into a complete system providing rapid access for public safety agencies, industries, military, and property owners across the world. The Knox Company is trusted by over 14,000 fire departments, law enforcement agencies, and governmental entities.

**KNOX COMPANY**  
1601 W. DEER VALLEY RD  
PHOENIX, AZ 85027

T. 800.552.5669  
F. 623.687.2290

**KNOXBOX.COM**  
INFO@KNOXBOX.COM